

OUTLINE DIMENSIONAL DRAWING

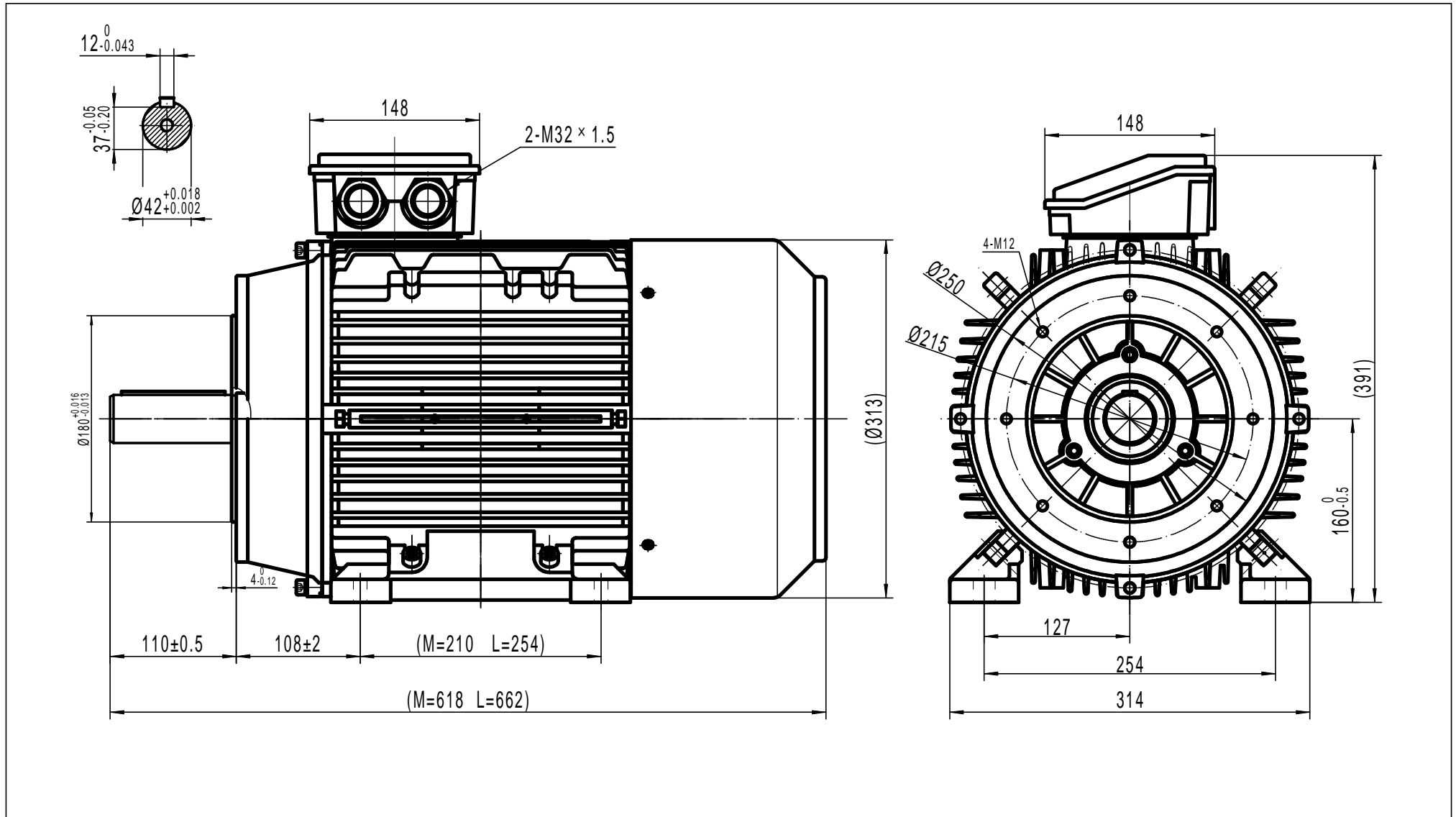

TECHTOP AUSTRALIA PTY LTD	
FRAME	TAI 160A B34
DATE	DRAWING NO.
2011/10/14	1ST087.052.001-032 A